

Clear Internal Dimensions - 1435mm x 590mm x 1440mm

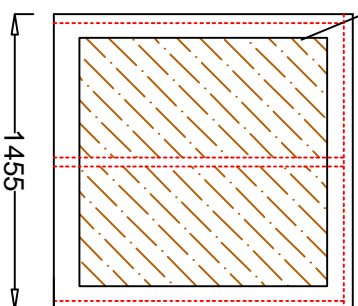

1220mm x 1220mm x 18mm Surface Treated Ply Backboard.



- 1No. Double door (1185 mm W x 1200mm H Clear Opening)
- 4No. S/St Hinges
- 1No. Yale type Lock
- 2No. Shoot Bolts
- 1No. Compression Seal

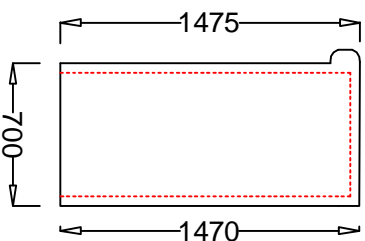
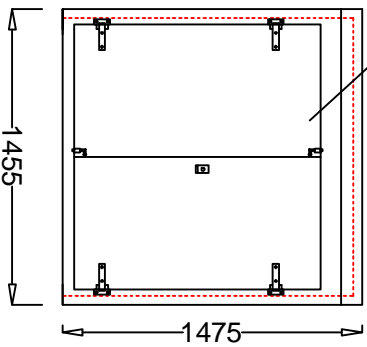
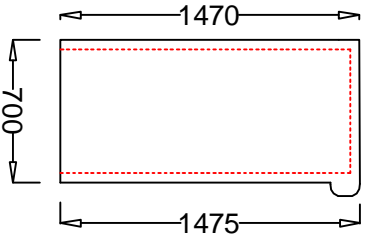

Adept GRP Ltd

Tel: 01269 843355

Tel: 01269 832189

Fax: 01269 844324

Unit 4, Heathfield Industrial Estate,
Thornhill Rd, Cwmgwilli, Crosshands
SA14 6PT

Company: ADEPT GRP Ltd

Contact: Vernon Phillips

Scheme Title: VR9

Drawn: Dan Phillips

Date: 14.06.13

Checked:

External Colour - BS or RAL

Construction: Single Skin const.

Drawing No. VR9

Job No. VR9

Rev: