

Clear Internal Dimensions - 1300mm x 290mm x 1250mm

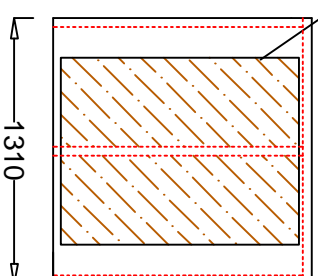

920mm x 1170mm x 18mm Surface Treated Ply Backboard.



- 1No. Double door (1160 mm W x 1010mm H Clear Opening)
- 4No. S/St Hinges
- 1No. Yale type Lock
- 2No. Shoot Bolts
- 1No. Compression Seal

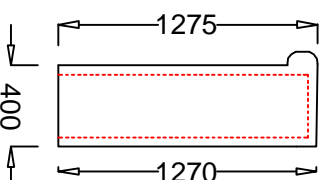
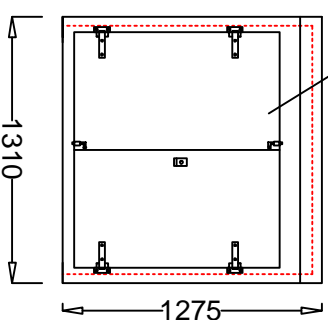
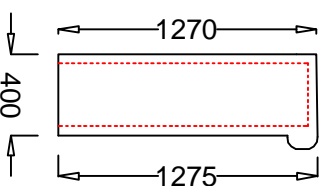

Adept GRP Ltd

Tel: 01269 843355

Tel: 01269 832189

Fax: 01269 844324

Unit 4, Heathfield Industrial Estate,
Thornhill Rd, Cwmgwilli, Crosshands
SA14 6PT

Company: ADEPT GRP Ltd

Contact: Vernon Phillips

Scheme Title: VR8

Drawn: Dan Phillips

Date: 13.06.13

Checked:

External Colour - BS or RAL

Construction: Single Skin const.

Drawing No. VR8

Job No. VR8

Rev: